

IS34EDE-H

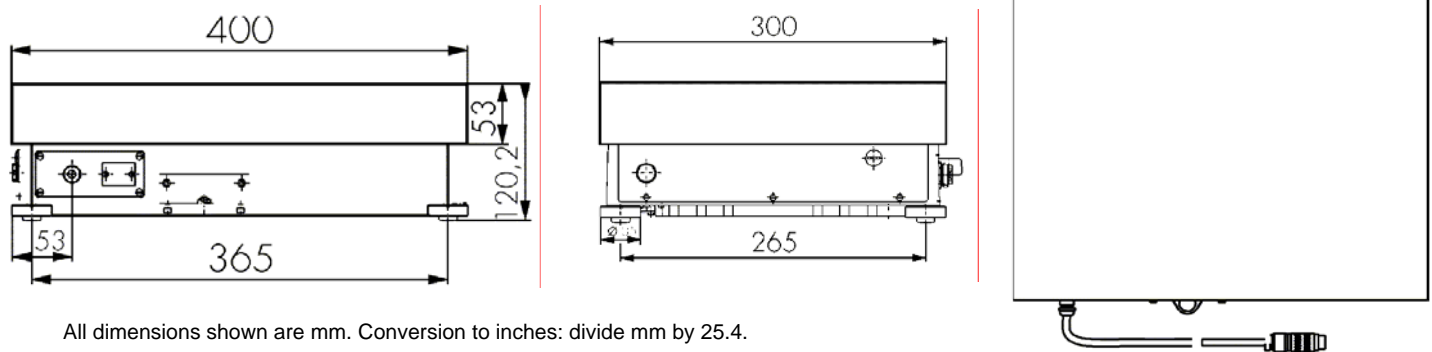

All dimensions shown are mm. Conversion to inches: divide mm by 25.4.

SPECIFICATIONS:

Weighing Capacity:	34kg / 75lb	Platform Size (WxD):	15.8" x 11.8"
Readability:	0.1g / 0.0002lb	Dimensions (WxHxD):	15.8" x 11.8" x 4"
Reproducibility:	± 0.1g	Platform Cable Length:	3 meter / 9.8'
Linearity:	± 0.2g	Net Weight:	16kg / 35lb
Response Time (Avg.):	1.5 second	Data Output Speed:	up to 50HZ
Operating Temp.:	+10° -> +30°	Base Construction:	Epoxy coated alum.
Protection Rating:	IP65 / NEMA 4	Max. Overload Capacity:	130kg / 286lb

FEATURES:

Connectable to Combics Indicators

Through an RS485 signal, the **IS34EDE-H** can be connected to a Combics **CIS__-IS** Indicator with its standard 3-meter (9') cable, or up to 300 meters (900') where longer distance is required.

Ultra fast Response Time

You won't have to wait more than one second for a stable readout with this platform. With special menu codes activated, you can actually reduce the response time down to 800ms!

Standard Internal Calibration

Simply press one key to calibrate the platform at any time. Internal calibration is especially useful when the scale gets moved from one location to another, or when the temperature varies considerably.

IP65 / NEMA 4 Protection Rating

The IP65 protection rating means that these scales are dust-tight and wash-down protected, making them suitable for use in some of the harshest industrial environments.

Connect directly to a computer

The Sartorius IS digital weighing platforms can be connected directly to a computer with optional RS232: YDO58IS.

Fast Data Communication

Depending upon the menu setting you select in the setup parameters, data outputs can be sent up to 50 times a second.

Sartorius Mechatronics Corporation
5 Orville Drive
Bohemia NY 11716

Toll Free: (800) 635-2906
☎ (631) 254-4249
Fax: (631) 254-4252

www.Sartorius-USA.com

Sartorius Canada
2179 Dunwin Dr. Units 4 & 5
Mississauga Ontario L5L 1X2

Toll Free: (800) 668-4264
☎ (905) 569-7977
Fax: (905) 569-7021